



**DIVERGENT SOFA
MDS.SO.DIV**

The Divergent Sofa defies the ordinary. It fragments the standards and preconceptions of what a sofa looks and feels like. Through captivating geometry and faceted surfaces, the long and deep seat is assuredly soft, the intriguing backrest is conceived for different heights and body types, while the piping keeps the edges sharp. The mirroring metal structures offer a lightness to its volume. It's a celebration for those who don't fit in, the divergent ones.

AS PICTURED

Upholstery: Olive velvet.

Footer and Back Detail: Stainless Steel in polished finishing.

FINISHES

Upholstery: All fabrics from the collection. Client's own material.

Footer and Back Detail: All fabrics from the collection. Client's own material. Wood Veneers and Metals from the collection. Lacquer.

STRUCTURE FEATURES

Frame in solid wood. Upholstery with straps.

Foam in 100% PU with BS standard fire specifications.

Combustion Modified High Resilience Foam.

Foam in American Standard CAL 117 for the USA.

Fire retardant interlining is available on request.

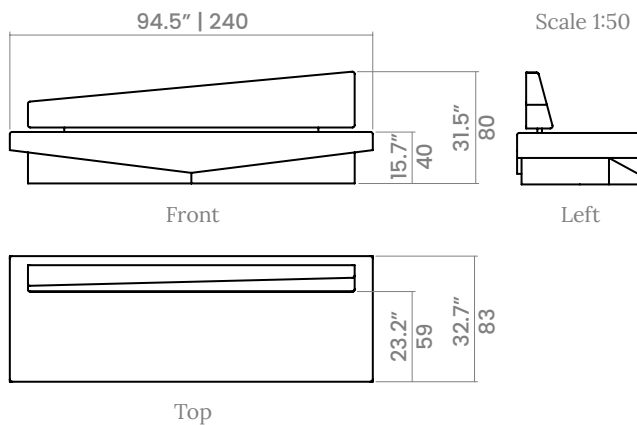

DIMENSIONS

Width: 94.5" | 240 cm
Depth: 32.7" | 83 cm
Height: 31.5" | 80 cm
Seat Height: 15.7" | 40 cm
Seat Depth: 23.2" | 59 cm
Suitable for custom sizes.

**CLIENT'S OWN MATERIAL (COM)
REQUIREMENTS**

334.6" | 8.5 m
** requirements based on plain fabric with a standard width of 55.1" | 1.4 m*

WEIGHT

198.4 lbs | 90 kg
Packed: (wooden case)
540 lbs | 245 kg

VOLUME

59.2 ft3 | 1.59 m3
Packed: (wooden case)
76.1 ft3 | 2.2 m3

All designs by Marta Delgado Studio are registered and protected by law. All intellectual property rights of the designs are owned by Marta Delgado Studio. Reproduction, modification or any other form of economic exploitation of such models is forbidden.

FABRICS

VELVET . 100%PL . MARTINDALE 150.000



WHITE



SAND

GREIGE

TAUPE

MUSTARD

RUST



GREY

STONE

OLIVE

MOSS

NAVY

VELVET FR . 100%PL . MARTINDALE 100.000



SAND



GREIGE

TAUPE

RUST

BLUSH

GREY



STONE

DARK GREY

MOSS

NAVY

VINTAGE . 66%PC + 34%PL . MARTINDALE 25.000



WHITE



GREIGE

SAND

TAUPE

RUST

BLUSH

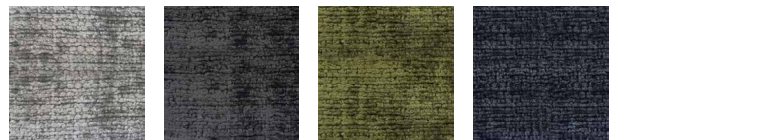

GREY

DARK GREY

MOSS

NAVY

All designs by Marta Delgado Studio are registered and protected by law. All intellectual property rights of the designs are owned by Marta Delgado Studio. Reproduction, modification or any other form of economic exploitation of such models is forbidden.

info@martadelgadostudio.com
www.martadelgadostudio.com

CORDED VELVETEEN . 100%CO . MARTINDALE 20.000

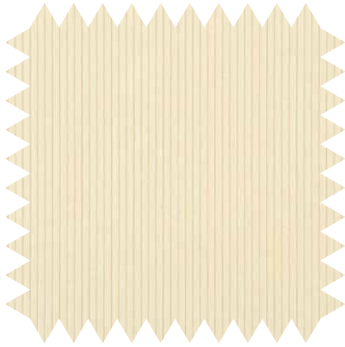

WHITE



GREY

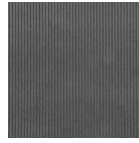

DARK GREY

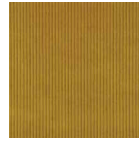

MUSTARD

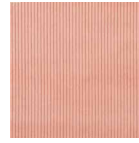

BLUSH



MOSS



ESPRESSO

BOUCLÉ . 34%VI + 33%PC + 17%WO + 8%PL + 4%LI + 4%CO .
MARTINDALE >50.000



WHITE



GREIGE

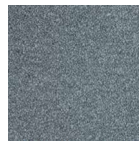

GREY

WIDE BOUCLÉ . 100%PL



WHITE

WOOD VENEER



AMERICAN WALNUT
GLOSS OR MATT

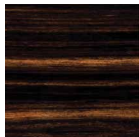

AMARA EBONY
GLOSS OR MATT



OAK
GLOSS OR MATT

LACQUER



ANY COLOR - RAL | NCS
GLOSS OR MATT

METAL



STAINLESS STEEL
POLISHED



STAINLESS STEEL
BRUSHED

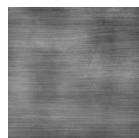

STAINLESS STEEL
OLD PATINE



BRASS
POLISHED



BRASS
BRUSHED



BRASS
OLD PATINE

All designs by Marta Delgado Studio are registered and protected by law. All intellectual property rights of the designs are owned by Marta Delgado Studio. Reproduction, modification or any other form of economic exploitation of such models is forbidden.

info@martadelgadostudio.com
www.martadelgadostudio.com